

Model ECXV40

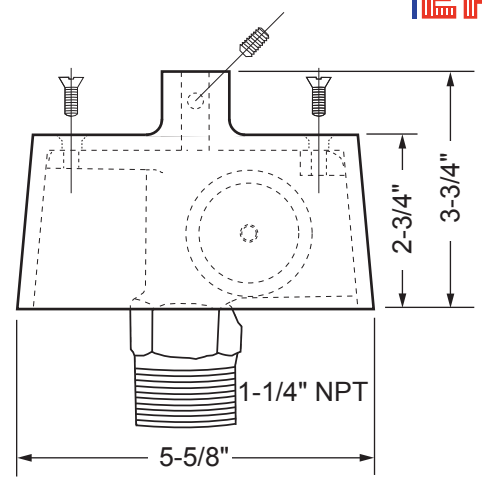

Truck Detail (IHT-VS)
 Cast aluminum construction
 Stationary truck
 2" outside diameter nylon sheave
 Top designed with 1/2" - 13NC to accept an ornament
 Stainless steel flathead screws for assembly

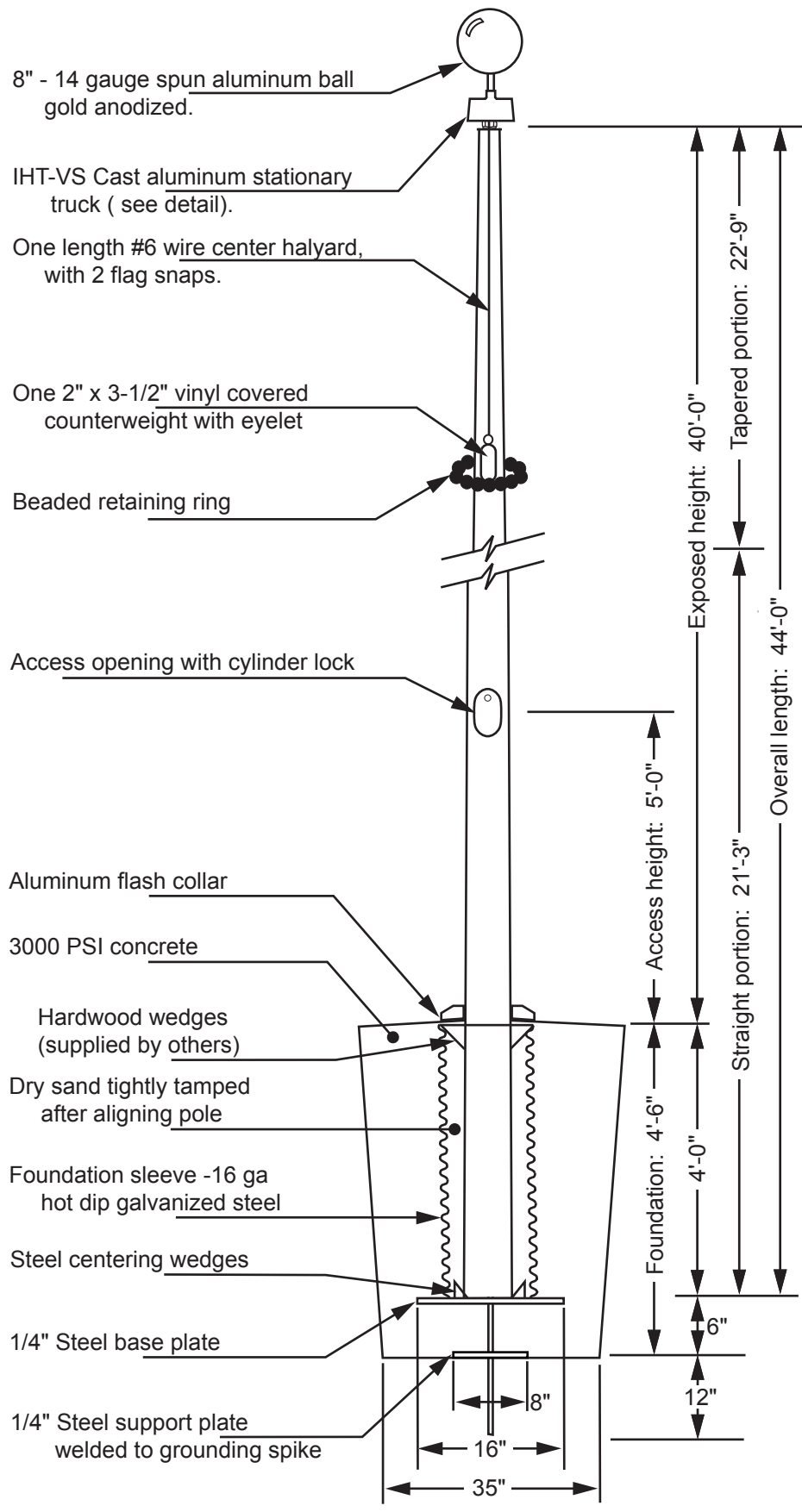
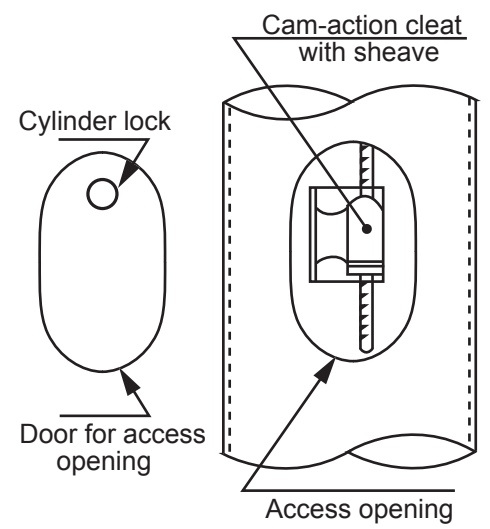

All shafts with overall length of more than 38'-6" are shipped in two sections.

Each section matched marked for field assembly. Exposed portion of jam sleeve must be **well lubricated** prior to assembly.

1-1/2" maximum shop gap allowed for field fitting (ram for tight joint)

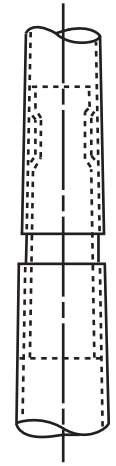

Filename: ECXV40 IHT-VS stationary truck Vanguard.ai

Project:	Ground set tapered aluminum flagpole: ALLOY: 6063T6	EDER FLAG	Date:
Location:	Exposed height: 40'-0"	Overall height: 44'-0"	MANUFACTURING COMPANY
Architect:	Ship in 2 section	Butt diameter: 7"	1000 W. Rawson Avenue
Contractor:	Top diameter: 3-1/2"	Wall thickness: .156"	Oak Creek, WI 53154
Customer:	Finish: 100 grit polish		Job:

DIAGRAMS ARE GUIDELINES ONLY: Parts indicated may not be included with your pole.